

Mercedes-Benz Places - Miami



A World Class Team



Mercedes-Benz

Mercedes-Benz is the first automotive brand to plan, create and operate places for future-oriented communities where mobility solutions merge with innovative living concepts. By looking beyond the car and putting the human factor in the center of thought, Mercedes-Benz and JDS Development Group aim to design holistic living ecosystems that adapt to the needs of their residents and guests.

Mercedes-Benz Places in Miami will provide a unique luxury experience with a strong sense of communal identity, created with a globally recognizable philosophy in terms of design, technology, quality and sustainability.







DEVELOPER

JDS DEVELOPMENT GROUP

JDS Development Group is a team of innovators and builders pioneering progressive new forms of large-scale urban development that challenge the status quo of the real estate industry. Founded in 2002 and headquartered in New York and Miami, JDS is a national firm focused on acquisition, development, and construction, recognized for its architecturally significant mixed-use projects that respond to each community and push the boundaries of engineering and design. JDS projects include Walker Tower, The Fitzroy, Stella Tower, other award-winning collaborations with the world's top architects and designers.

Mercedes-Benz Places in Miami represents the fourth large-scale project between JDS and SHoP Architects. Other JDS and SHoP projects include the recently completed supertall 111 West 57th Street in Manhattan, on the ultra-luxury Central Park facing condominiums; Brooklyn's first supertall The Brooklyn Tower, a mixed-use project of condominiums and rental apartments with retail in its base and the historic Dime Savings Bank of Brooklyn; and The American Copper Buildings on Manhattan's East River, a pair of copper-clad "dancing" towers with a skybridge and 760 luxury rental apartments.

JDS has long been active in the South Florida market, achieving record sales for Echo Brickell, Echo Aventura, and Monad Terrace by Ateliers Jean Nouvel. In the summer of 2023, JDS announced the supertall at 888 Brickell, Dolce&Gabbana, Miami, a condo-hotel project with the global fashion house

ARCHITECT

sh p

SHoP Architects is a New York-based global design leader, with iconic projects completed or underway across more than 72 million square feet on five continents. SHoP takes a high performance approach to design and planning that introduces definitive new and enduring architecture to the great city skylines and streetscapes.

Notable projects include Brooklyn's Barclays Center, the American Copper Buildings and the supertall residential tower 111 West 57th Street in Manhattan, the new Uber Headquarters in San Francisco, the recently opened Collins Arch complex in Melbourne, Fulbright University Vietnam, Codrico Tower Rotterdam, and multiple diplomatic facilities including in Milan and Bangkok, under a Design Excellence contract with the U.S. Department of State.

The diverse and trendsetting work of the firm has been widely celebrated with a variety of honors, among them the Smithsonian's National Design Award for Architecture.





INTERIOR DESIGNER

W-BTM
WOODS BAGOT

Woods Bagot is a global architecture studio specializing in architecture, interiors and master planning. The interior design team, under the leadership of Krista Ninivaggi, curates innovative spaces for a diverse and forward thinking clientele, ranging from lawyers to DJs. The team specializes in bespoke interiors that work in harmony with the existing architectural context. A meticulous attention to detail instills even the largest projects with a boutique feel. From welcoming residential spaces to progressive workplaces to conceptual hospitality programming, the team's designs promote new and unexpected interactions fostering a broader range of unexpected collaborations and innovation.

LANDSCAPE ARCHITECT

FIELD OPERATIONS

Founded in 1999, Field Operations is a leading-edge landscape architecture and urban design practice based in New York City, with offices in San Francisco, Philadelphia, Shenzhen and London. Field Operations is renowned for strong contemporary design across a variety of project types and scales, from large urban districts, master plans and complex planning sites, to small well-crafted, detailed design projects. Regardless of scale, there is a special commitment to the design of a vibrant and dynamic public realm, informed by the ecology of both people and nature, rooted in place and context.

The ultimate aim is to bring beauty, health and vitality to the different kinds of environments where people live and interact. Given the current day urgency of creatively addressing challenges of changing climate, diminishing resources, environmental decline, social inequity and rapid urbanization, they focus upon design that thinks and acts big, that elegantly solves real problems, and shapes amore sustainable and resilient world for everybody.

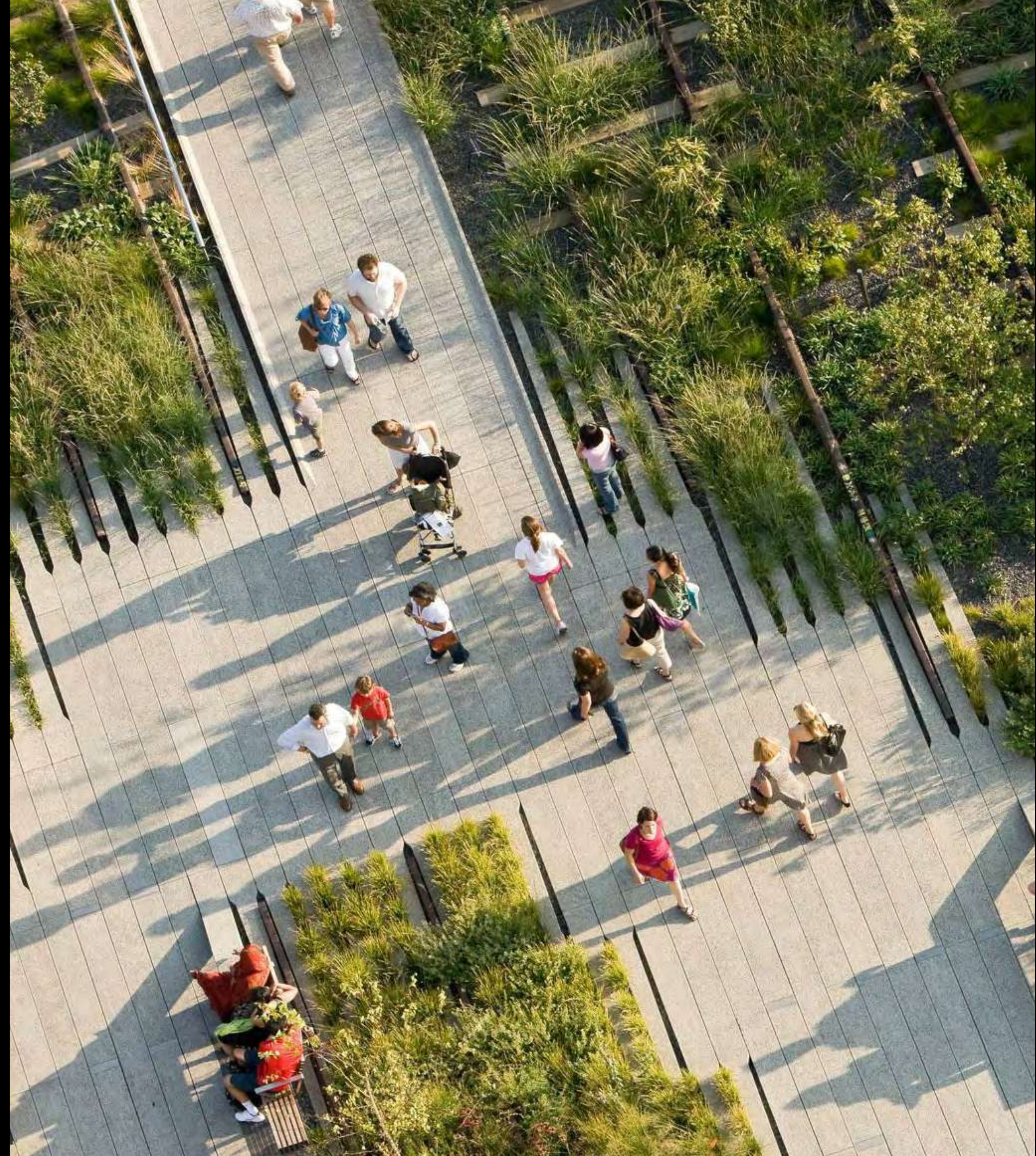



ARTIST'S RENDERING

EXCLUSIVE SALES AND MARKETING

SERHANT.

NEW DEVELOPMENT

SERHANT. is the first real estate company launched and designed for the marketplace of tomorrow. It grew from the #1 ranked sales team in New York City into a full-service firm that is revolutionizing the traditional real estate model.

SERHANT. New Development gives developers and financial institutions an unmatched advantage by providing insightful and results-oriented step-by-step guidance and support from site acquisition to final sellout for projects of all sizes, price points, and locations. It uses comprehensive market analytics to hone planning, design, and branding strategies, and it leverages SERHANT. Studios and ID Lab to deliver potent, breakthrough content and sales campaigns that are targeted and amplified through SERHANT. ADX, a tech-powered innovation platform.

The Brickell Neighborhood



Between architectural jewels and hidden gems, high-end restaurants and low-key bars, Brickell sits at the intersection of Miami's most-coveted dining, shopping, and work-life experiences. Indulge in the luxury of city living surrounded by a distinct sense of community and sunshine, where unparalleled access to urban and natural amenities support the bustling world-class offices, hotels, and residences. The distinct skyline and cityscape create stunning day views and night city lights, while the water provides access to endless recreational activities such as boating, paddle boarding, kayaking, and more in the enviable year-round sunshine.

Brickell is where the city meets the neighborhood and nature. Here, Mercedes-Benz Places in Miami emerges as an unparalleled and vibrant destination.



Culture & Entertainment

1. BRICKELL CITY CENTRE .5 MILES
2. SOUTHSIDE PARK 0 MILES
3. SIMPSON PARK HAMMOCK .6 MILES
4. THE FOUR SEASONS .7 MILES
5. HISTORYMIAMI MUSEUM 1 MILE
6. MARY BRICKELL VILLAGE .7 MILES

Additional

- BAYFRONT PARK 1.3 MILES
- BAYSIDE MARKETPLACE 1.5 MILES
- FREEDOM TOWER 1.5 MILES
- SKY VIEWS OBSERVATION WHEEL 1.6 MILES
- KASEYA CENTER (HOME OF MIAMI HEAT) 1.6 MILES
- ADRIENNE ARSHT CENTER FOR THE PERFORMING ARTS 2 MILES
- MAURICE A. FERRE PARK 2 MILES
- MUSEUM PARK 2 MILES
- FROST SCIENCE MUSEUM 2 MILES
- PEREZ ART MUSEUM MIAMI 2 MILES

Culinary & Nightlife

7. SEXY FISH MIAMI .2 MILES
8. DIRTY FRENCH .4 MILES
9. GEKKO .4 MILES
10. KOMODO .6 MILES
11. OSAKA .6 MILES
12. LPM RESTAURANT & BAR .6 MILES
13. CAVIAR RUSSE .6 MILES
14. ZUMA 1 MILE

Additional

- 24-HOUR NIGHTLIFE DISTRICT 1.6 MILES

Notable Points of Interest

15. BRICKELL FINANCIAL DISTRICT .4 MILES

Additional

- WYNWOOD ARTS DISTRICT 1.9 MILES
- LOANDEPOT PARK 2.2 MILES
- ARTS & ENTERTAINMENT DISTRICT 2.7 MILES
- PORTMIAMI 2.7 MILES
- UNIVERSITY OF MIAMI 2.7 MILES
- YACHT HAVEN GRANDE MARINA AT ISLAND GARDENS 3 MILES
- JACKSON HOSPITAL/UNIVERSITY OF MIAMI HEALTH DISTRICT 3 MILES
- MIAMI CHILDREN'S MUSEUM 3 MILES
- PARROT JUNGLE 3 MILES
- MIDTOWN MIAMI 3 MILES
- COCONUT GROVE 3.5 MILES
- MIAMI DESIGN DISTRICT 3.7 MILES
- INSTITUTE OF CONTEMPORARY ART 3.7 MILES
- CORAL GABLES 4.7 MILES
- SOUTH BEACH 6.2 MILES
- KEY BISCAYNE 8.5 MILES
- HARD ROCK STADIUM 17 MILES
- INTER MIAMI CF STADIUM 36 MILES

Transit

16. BRICKELL METRO MOVER STATION .1 MILES
17. THE UNDERLINE .2 MILES

Additional

- MIAMICENTRAL STATION 1.3 MILES
- BRIGHTLINE HIGH SPEED RAIL 1.3 MILES
- MIAMI INTERNATIONAL AIRPORT 7.1 MILES
- MIAMI OPA-LOCKA EXECUTIVE AIRPORT 14 MILES
- FORT LAUDERDALE-HOLLYWOOD INTERNATIONAL 29 MILES

Why Brickell, Miami?

- ⤴ Referred to as “The Manhattan of the South,” Brickell is home to the largest concentration of International banks in the U.S.
- ⤴ Brickell is home to the UnderLine, Miami’s own version of New York’s Highline, stretching 10 miles of running paths and parks throughout connecting neighborhoods.
- ⤴ Miami has seen a major influx of tech and financial firms relocating their corporate headquarters to the city, including LexerX, Rothschild & Co., and Citadel.
- ⤴ Miami was considered as 2024’s most dynamic culinary destination in the U.S. by the Financial Times.
- ⤴ Miami is ranked 6th on WalletHub’s list of the best sports cities in America for 2023 and named as the 2026 World Cup Host City.
- ⤴ Knight Frank ranked Miami as the 5th top city for the world’s ultra-rich, following London, New York, Los Angeles and Hong Kong in 2023.
- ⤴ U.S. News & World Report 2023 ranked Miami as one of the best places to live in the U.S.
- ⤴ Miami makes Forbes’ Top 10 “List of Best Places To Live In Florida In 2023.”
- ⤴ TIME’s World’s Best Cities 2023 ranked Miami 6th as one of the best cities in America.
- ⤴ Time Out ranked Miami as the #2 spot for nightlife, outshining destinations like Berlin and Singapore in 2023.
- ⤴ Miami has been named one of the Top 10 cities in America, according to a 2023 ranking by the placemaking firm Resonance.
- ⤴ Known as the “Gateway to Latin America” Miami is the second-largest tourism hub and has the largest number of international flights in the United States, following New York City.



The Building

Timeless Design, Inspired by Miami

Mercedes-Benz' first residential project in North America weaves mobility solutions with unparalleled standards of innovative living to create a visionary community. With luxurious condominium residences, office and wellness spaces, a worldclass hotel, and newly-built open park by Field Operations, the project establishes a one-of-a-kind, future-oriented experience.

Welcome to the distinctive urban oasis that combines sophistication, convenience, and sustainable living in one extraordinary location.



ARTIST'S RENDERING

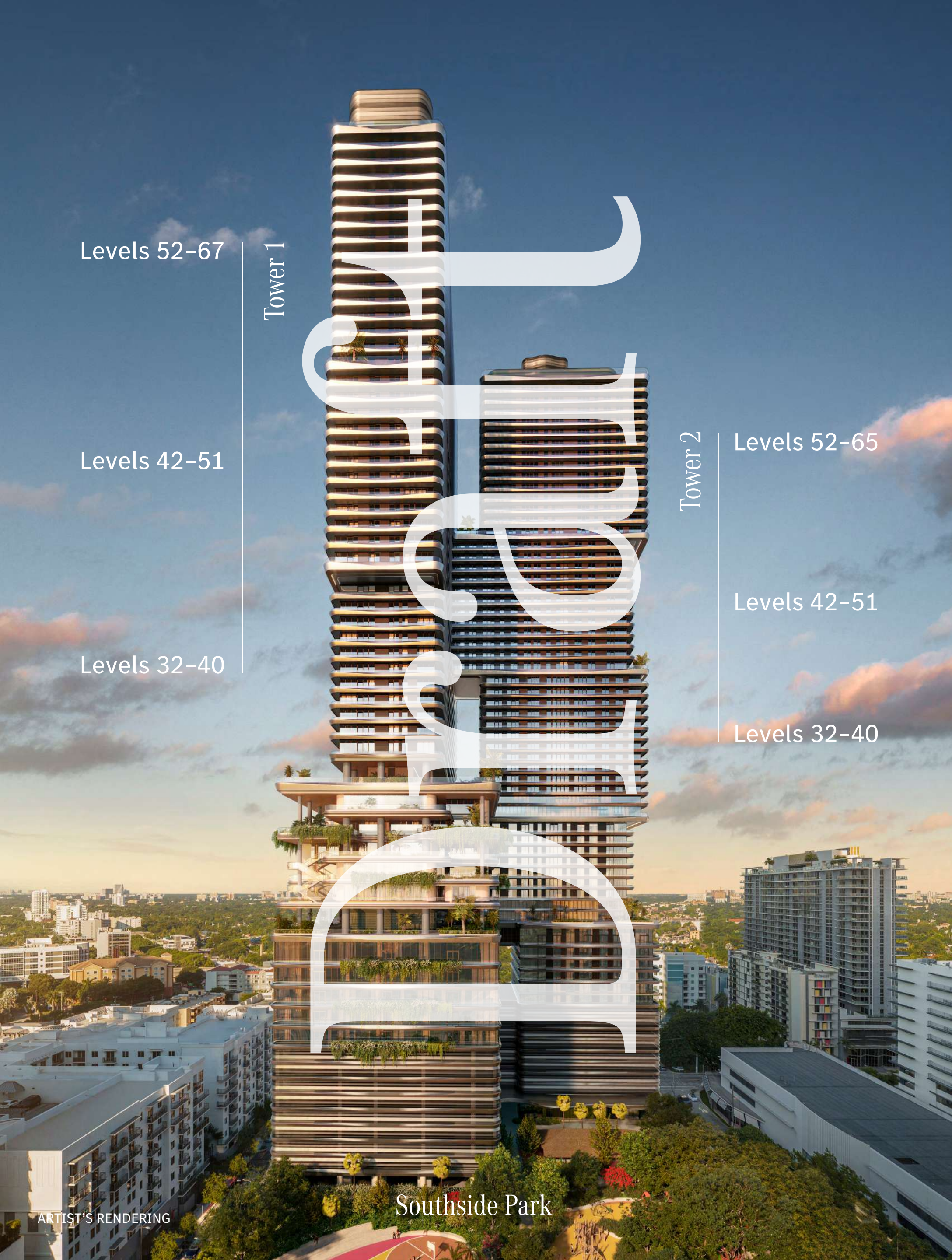

Levels 52-67

Tower 1

Levels 42-51

Levels 32-40

Tower 2

Levels 52-65

Levels 42-51

Levels 32-40

SBI

Southside Park

ARTIST'S RENDERING

Luxury Rooted in Design, Technology, Quality and Sustainability



ARTIST'S RENDERING

The Park



Southside Park

The newly-designed Southside Park is one of the largest green spaces in Brickell, supporting community gathering. The park serves as a connective node to the Brickell neighborhood through the pathways of Miami's recently opened and celebrated UnderLine (also by Field Operations). The entire city block is conceived as a harmonious pedestrian and public realm. The energy and experience of the city is drawn through the park at the ground level, creating an integrated pedestrian experience that, rising with the building, redefines and extends it into the sky.

A Green Haven in Brickell

- ▲ Padel ball courts
- ▲ Basketball court
- ▲ Dog run
- ▲ Water feature
- ▲ Children's playground
- ▲ Walking pathways connected to the UnderLine



ARTIST'S RENDERING



Draft

ARTIST'S RENDERING



ARTIST'S RENDERING

The Amenities

Unmatched Amenities and Services

130,000 total square feet of amenity and hospitality space, from the park to the pools to the rooftop.

- ✦ Exclusive rooftop pool for residents
- ✦ Café
- ✦ Two signature restaurants
- ✦ Cocktail bar
- ✦ Sun and garden pools with towel and F&B services
- ✦ Residents' Lounges
- ✦ Co-working spaces and library
- ✦ Screening room
- ✦ Custom Mercedes-Benz race car simulator
- ✦ Recording studio
- ✦ Outdoor kitchen and dining area
- ✦ Mercedes-Benz house cars
- ✦ 24/7 concierge
- ✦ EV charging stations



ARTIST'S RENDERING

Draft

ARTIST'S RENDERING

Draft

ARTIST'S RENDERING



ARTIST'S RENDERING



ARTIST'S RENDERING

Wellness

An unmatched selection of wellness amenities at Mercedes-Benz Place Miami engage the senses and speak to every interest, which includes:

- Series of saunas (hot, dry, and infra-red)
- Onsen ritual circuit
- Cabanas
- Himalayan salt room
- Aromatherapy room
- Steam room
- Fitness Center



ARTIST'S RENDERING



Draft

ARTIST'S RENDERING

Draft

ARTIST'S RENDERING

Draft

ARTIST'S RENDERING

Residences.
Every Detail
Considered.

Refined Detailing. Contrasting Surfaces.

Designed by the interiors experts Woods Bagot, residences are an immersion in modernity and luxury.

10-foot, floor-to-ceiling windows frame the phenomenon of the Miami sunset — and the most fascinating views of the city. Terraces lure in the light.



ARTIST'S RENDERING

Miami Living. Elevated.

Beauty elevates the innovative, exclusive, and sustainable features of the Residences at Mercedes-Benz Place Miami into highly desirable emotional experiences.

From studios to three-bedrooms, each residence is an immersion in modernity and luxury, meticulously conceived and created by the interiors experts Woods Bagot.

- ▲ 10' floor-to-ceiling windows
- ▲ 5' deep terraces
- ▲ Engineered hardwood floors throughout
- ▲ Miele washer and dryer
- ▲ Custom fixtures in chrome finish
- ▲ Integrated in-home technology



ARTIST'S RENDERING



ARTIST'S RENDERING



Draft

ARTIST'S RENDERING



ARTIST'S RENDERING

Kitchen

Custom Woods Bagot designed kitchens in light and dark finish options, featuring fluted glass inlays, and integrated emblem pulls, polished chrome toe kick and grille, and integrated under cabinet lighting.

- ▲ Fully custom islands with oil rubbed bronze cabinetry and dine-in counter
- ▲ Tinted etched mirror backsplash with integrated technology screen
- ▲ Custom plumbing fixtures in chrome finish
- ▲ Fully integrated suite of Miele appliances including: refrigerator, induction cooktop, convection oven, dishwasher, refrigerator, and speed oven

Light Finish

- ▲ Super white-stained red oak lower cabinetry
- ▲ White lacquered framed doors
- ▲ Virginia Black Granite countertops





Dark Finish

- ▲ Slate grey-stained walnut lower cabinetry
- ▲ Black lacquer framed doors
- ▲ Limestone countertops

Principal Bathroom

- ▲ Nero Marquina or Bianco Gioia marble flooring and shower with fully integrated rainshower head, illuminated Bianco Gioia marble ledge reveal and fluted glass doors
- ▲ Floating vanity with Gioia marble countertops and fluted slate-grey walnut inlay doors, custom emblem pulls, and custom lighting
- ▲ Custom chrome faucets and shower systems
- ▲ Kohler sinks, toilets and tubs
- ▲ Available in light and dark finish options
- ▲ Medicine cabinets*
*In select residences



ARTIST'S RENDERING



ARTIST'S RENDERING



ARTIST'S RENDERING

Second Bath

- ▲ Floating vanity with Gioia marble countertops and fluted slate-grey walnut inlay doors, custom emblem pulls, and custom lighting
- ▲ Kohler sinks and toilets
- ▲ Custom chrome faucets and fixtures
- ▲ Nero Marquina (dark finish) or Gioia marble (light finish) flooring

Powder Room

- ▲ A custom design featuring Nero Marquina backsplash and wainscot base, dark limewash, and integrated edge lit mirror
- ▲ Kohler sinks and toilets
- ▲ Custom chrome faucets and fixtures
- ▲ Nero Marquina (dark finish) or Gioia marble (light finish) flooring



ARTIST'S RENDERING



Residence 03

FLOORS 32-40

- South Tower
- Studio
- 1 Bathroom
- Interior: 403 sq ft
- Terrace: 63 sq ft

FEATURES

- Studio residence with North exposure
- 10' floor-to-ceiling windows and sliding glass doors with direct access to 5' deep terraces

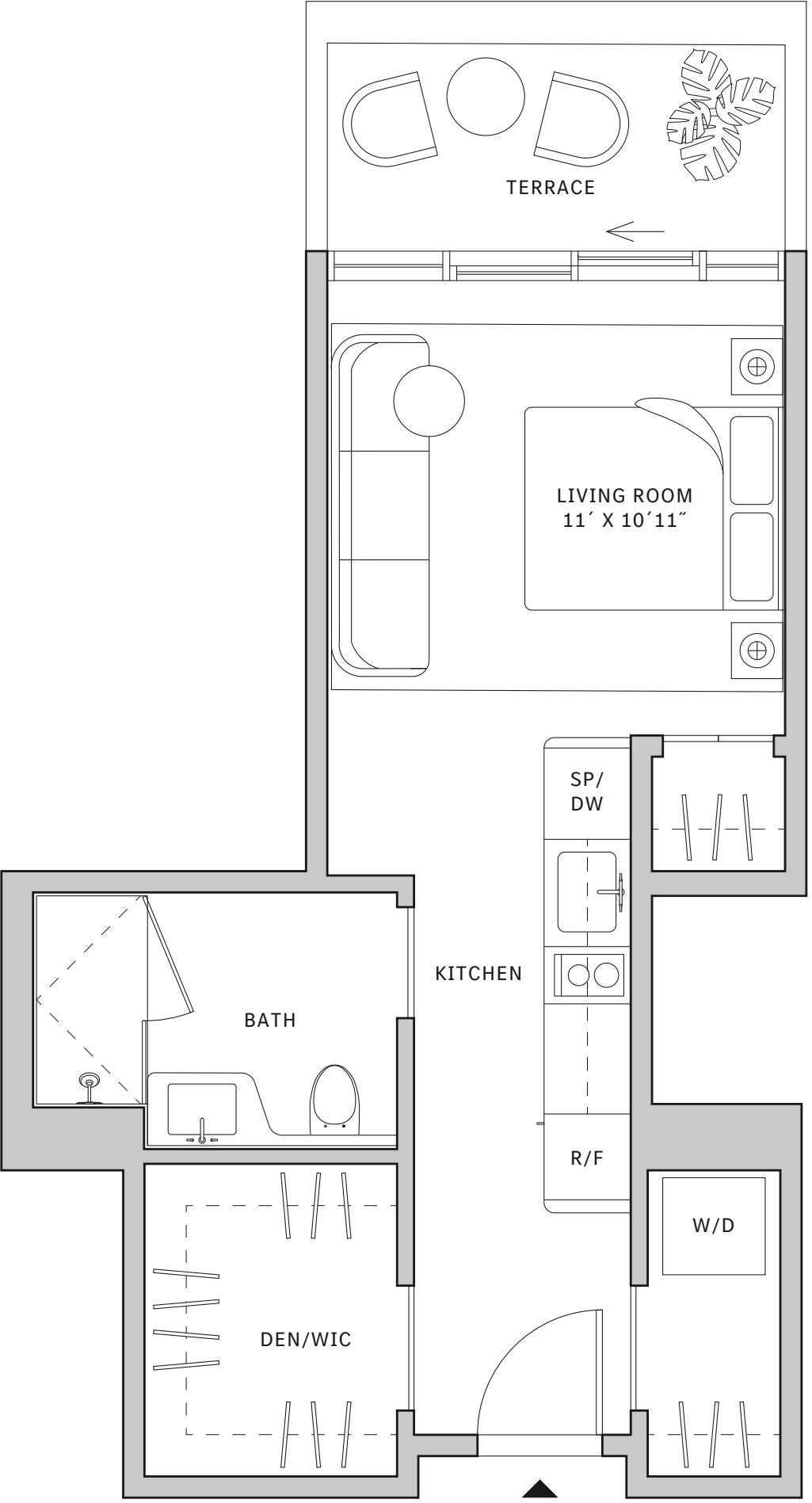
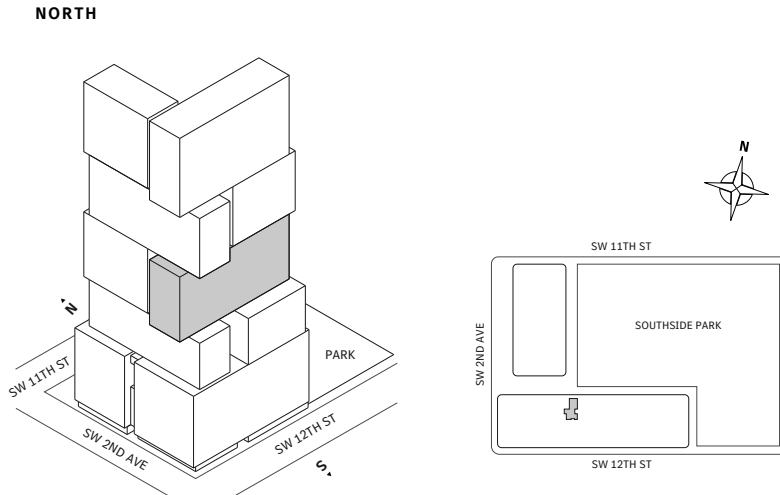

MIAMI.MERCEDESBNZPLACES.COM

Developed by JDS DEVELOPMENT GROUP
Exclusive Sales & Marketing by SERHANT. NEW DEVELOPMENT.

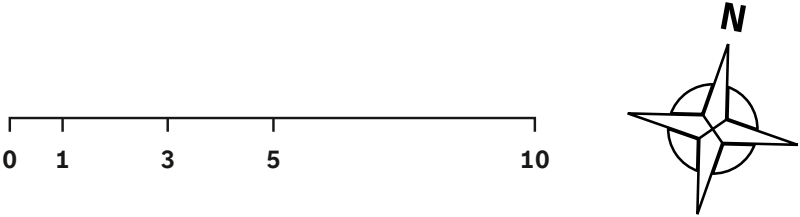

STATED DIMENSIONS ARE MEASURED TO THE EXTERIOR BOUNDARIES OF THE EXTERIOR WALLS AND THE CENTERLINE OF INTERIOR DEMISING WALLS AND IN FACT VARY FROM THE DIMENSIONS THAT WOULD BE DETERMINED BY USING THE DESCRIPTION AND DEFINITION OF THE "UNIT" SET FORTH IN THE DECLARATION (WHICH GENERALLY ONLY INCLUDES THE INTERIOR AIRSPACE BETWEEN THE PERIMETER WALLS AND EXCLUDES INTERIOR STRUCTURAL COMPONENTS). FOR YOUR REFERENCE, THE AREA OF THE UNIT, DETERMINED IN ACCORDANCE WITH THOSE DEFINED UNIT BOUNDARIES, IS SET FORTH IN EXHIBIT 3 TO THE DECLARATION OF THE CONDOMINIUM. NOTE THAT MEASUREMENTS OF ROOMS SET FORTH ON THIS FLOOR PLAN ARE GENERALLY TAKEN AT THE GREATEST POINTS OF EACH GIVEN ROOM (AS IF THE ROOM WERE A PERFECT RECTANGLE), WITHOUT REGARD FOR ANY CUTOUTS. ACCORDINGLY, THE AREA OF THE ACTUAL ROOM WILL TYPICALLY BE SMALLER THAN THE PRODUCT OBTAINED BY MULTIPLYING THE STATED LENGTH TIMES WIDTH. ALL DIMENSIONS ARE APPROXIMATE AND MAY VARY WITH ACTUAL CONSTRUCTION, AND ALL FLOOR PLANS AND DEVELOPMENT PLANS ARE SUBJECT TO CHANGE.





Residence 11

FLOORS 32 - 40

- ▲ South Tower
- ▲ 1 Bedroom
- ▲ 1 Bathroom
- ▲ 1 Den/Office
- ▲ Interior: 728 sq ft
- ▲ Terrace: 127 sq ft

FEATURES

- ▲ One bedroom residence with South exposure
- ▲ 10' floor-to-ceiling windows and sliding glass doors with direct access to 5' deep terrace

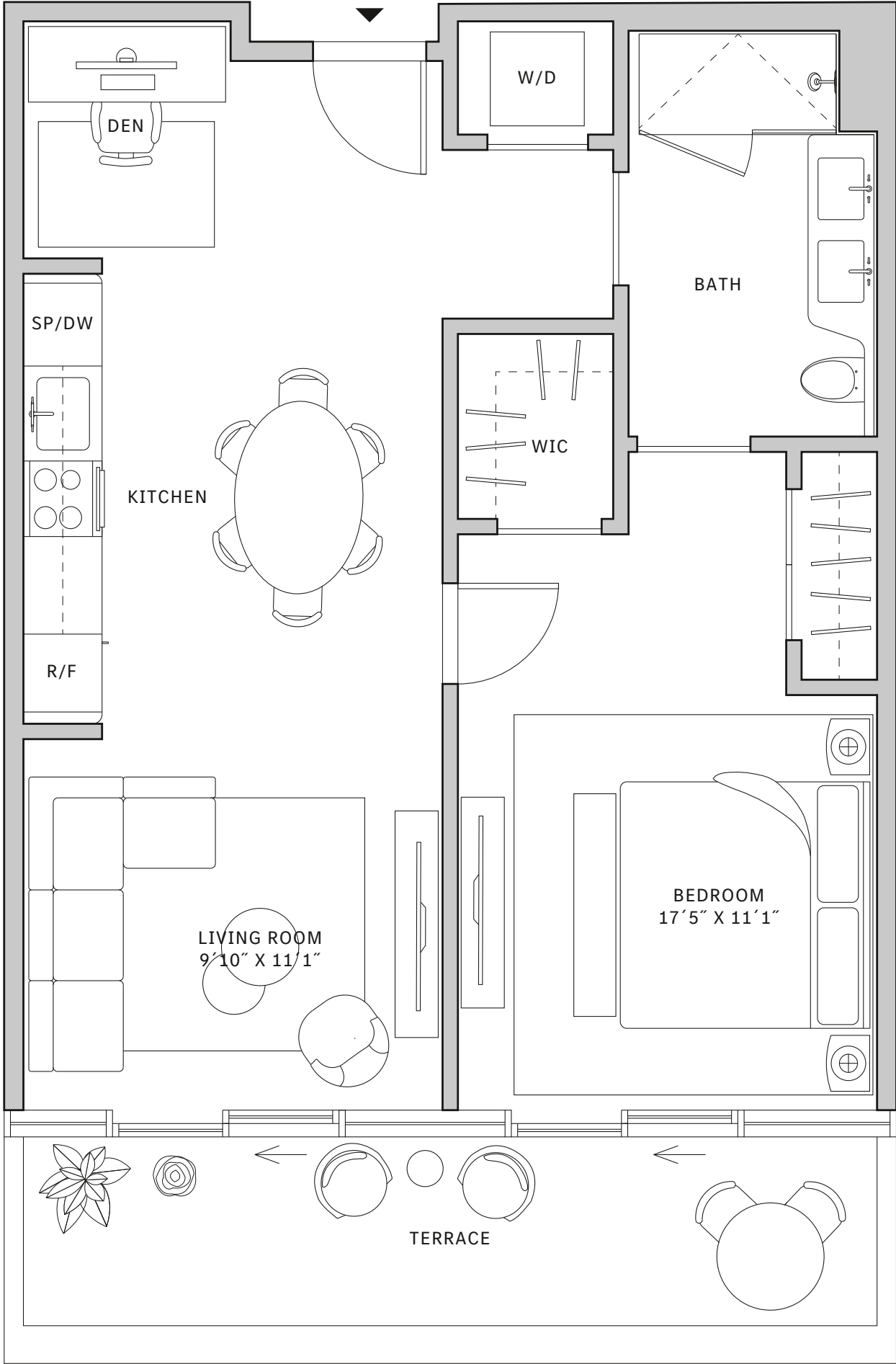
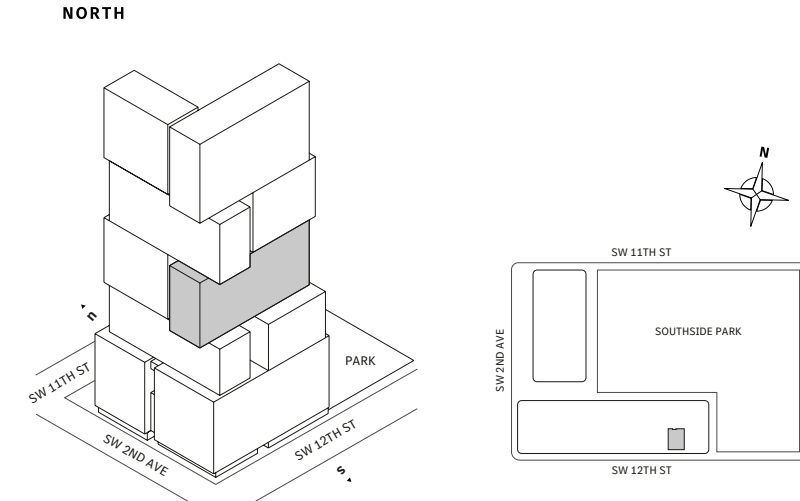

MIAMI.MERCEDESBNZPLACES.COM

Developed by JDS DEVELOPMENT GROUP
 Exclusive Sales & Marketing by SERHANT. NEW DEVELOPMENT.

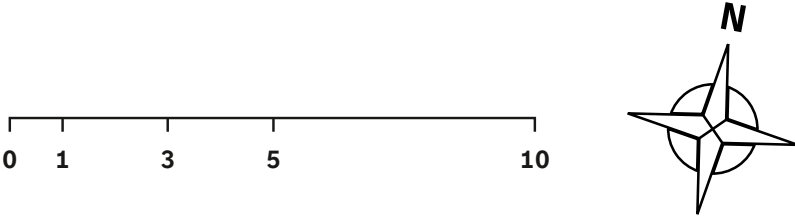

STATED DIMENSIONS ARE MEASURED TO THE EXTERIOR BOUNDARIES OF THE EXTERIOR WALLS AND THE CENTERLINE OF INTERIOR DEMISING WALLS AND IN FACT VARY FROM THE DIMENSIONS THAT WOULD BE DETERMINED BY USING THE DESCRIPTION AND DEFINITION OF THE "UNIT" SET FORTH IN THE DECLARATION (WHICH GENERALLY ONLY INCLUDES THE INTERIOR AIRSPACE BETWEEN THE PERIMETER WALLS AND EXCLUDES INTERIOR STRUCTURAL COMPONENTS). FOR YOUR REFERENCE, THE AREA OF THE UNIT, DETERMINED IN ACCORDANCE WITH THOSE DEFINED UNIT BOUNDARIES, IS SET FORTH IN EXHIBIT 3 TO THE DECLARATION OF THE CONDOMINIUM. NOTE THAT MEASUREMENTS OF ROOMS SET FORTH ON THIS FLOOR PLAN ARE GENERALLY TAKEN AT THE GREATEST POINTS OF EACH GIVEN ROOM (AS IF THE ROOM WERE A PERFECT RECTANGLE), WITHOUT REGARD FOR ANY CUTOUTS. ACCORDINGLY, THE AREA OF THE ACTUAL ROOM WILL TYPICALLY BE SMALLER THAN THE PRODUCT OBTAINED BY MULTIPLYING THE STATED LENGTH TIMES WIDTH. ALL DIMENSIONS ARE APPROXIMATE AND MAY VARY WITH ACTUAL CONSTRUCTION, AND ALL FLOOR PLANS AND DEVELOPMENT PLANS ARE SUBJECT TO CHANGE.





Residence 12

FLOORS 32 - 40

- South Tower
- 2 Bedrooms
- 2 Bathrooms
- Interior: 1,253 sq ft
- Terrace: 308 sq ft

FEATURES

- Two bedroom residence with South exposure
- 10' floor-to-ceiling windows and sliding glass doors with direct access to 5' deep terrace

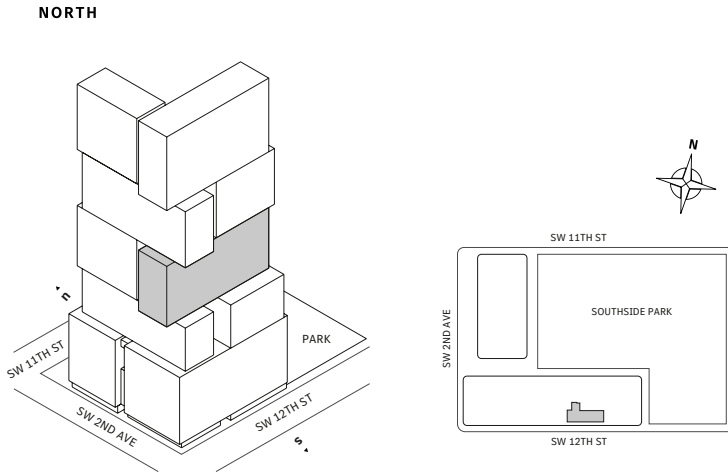
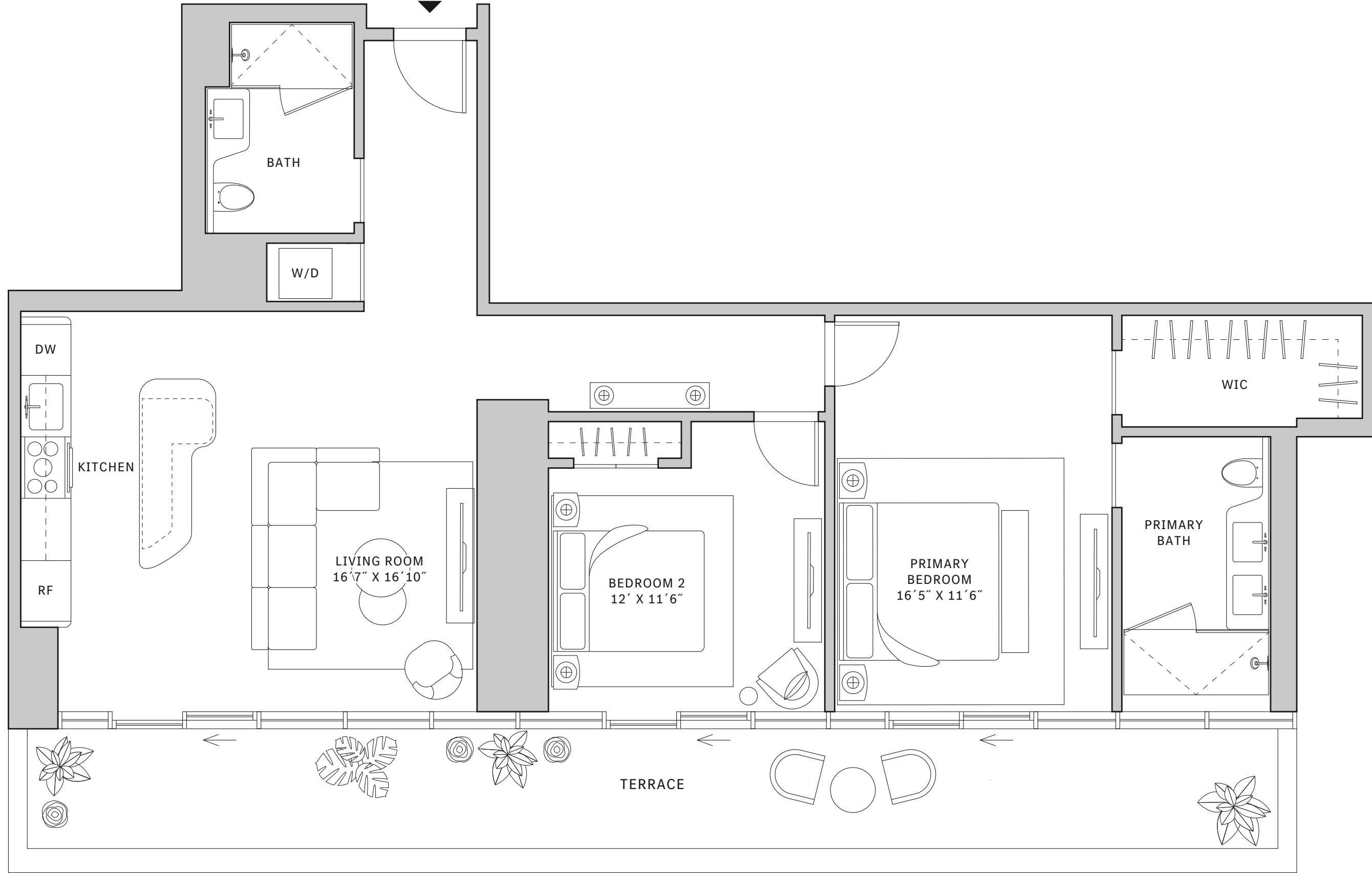

MIAMI.MERCEDESBNZPLACES.COM

Developed by JDS DEVELOPMENT GROUP
Exclusive Sales & Marketing by SERHANT. NEW DEVELOPMENT.

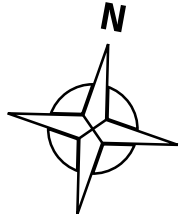
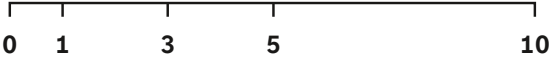

STATED DIMENSIONS ARE MEASURED TO THE EXTERIOR BOUNDARIES OF THE EXTERIOR WALLS AND THE CENTERLINE OF INTERIOR DEMISING WALLS AND IN FACT VARY FROM THE DIMENSIONS THAT WOULD BE DETERMINED BY USING THE DESCRIPTION AND DEFINITION OF THE "UNIT" SET FORTH IN THE DECLARATION (WHICH GENERALLY ONLY INCLUDES THE INTERIOR AIRSPACE BETWEEN THE PERIMETER WALLS AND EXCLUDES INTERIOR STRUCTURAL COMPONENTS). FOR YOUR REFERENCE, THE AREA OF THE UNIT, DETERMINED IN ACCORDANCE WITH THOSE DEFINED UNIT BOUNDARIES, IS SET FORTH IN EXHIBIT 3 TO THE DECLARATION OF THE CONDOMINIUM. NOTE THAT MEASUREMENTS OF ROOMS SET FORTH ON THIS FLOOR PLAN ARE GENERALLY TAKEN AT THE GREATEST POINTS OF EACH GIVEN ROOM (AS IF THE ROOM WERE A PERFECT RECTANGLE), WITHOUT REGARD FOR ANY CUTOUTS. ACCORDINGLY, THE AREA OF THE ACTUAL ROOM WILL TYPICALLY BE SMALLER THAN THE PRODUCT OBTAINED BY MULTIPLYING THE STATED LENGTH TIMES WIDTH. ALL DIMENSIONS ARE APPROXIMATE AND MAY VARY WITH ACTUAL CONSTRUCTION, AND ALL FLOOR PLANS AND DEVELOPMENT PLANS ARE SUBJECT TO CHANGE.





Residence 01

FLOOR 32 - 40

- ▲ South Tower
- ▲ 3 Bedrooms
- ▲ 3 Bathrooms
- ▲ 1 Den/Office
- ▲ 1 Powder Room
- ▲ Interior: 2,116 sq ft
- ▲ Terrace: 602 sq ft

FEATURES

- ▲ Corner three-bedroom residence with panoramic West to North exposure
- ▲ 10' floor-to-ceiling windows and sliding glass doors with direct access to 5' deep wrap-around terraces

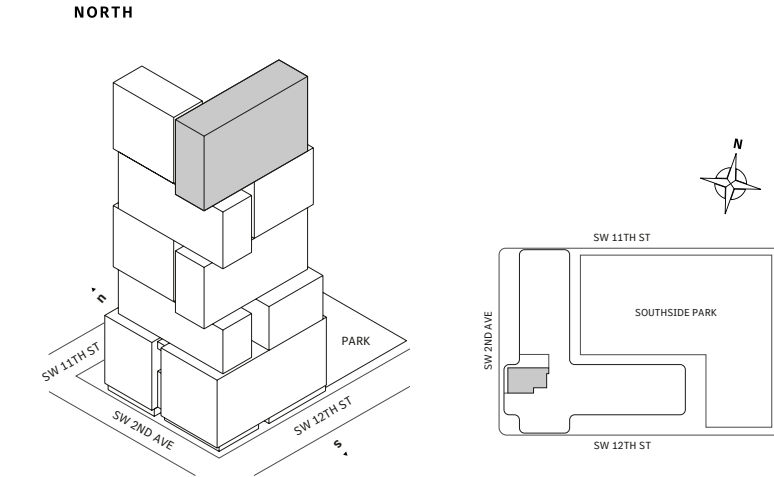

MIAMI.MERCEDESBNZPLACES.COM

Developed by JDS DEVELOPMENT GROUP
 Exclusive Sales & Marketing by SERHANT. NEW DEVELOPMENT.

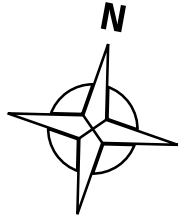
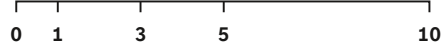
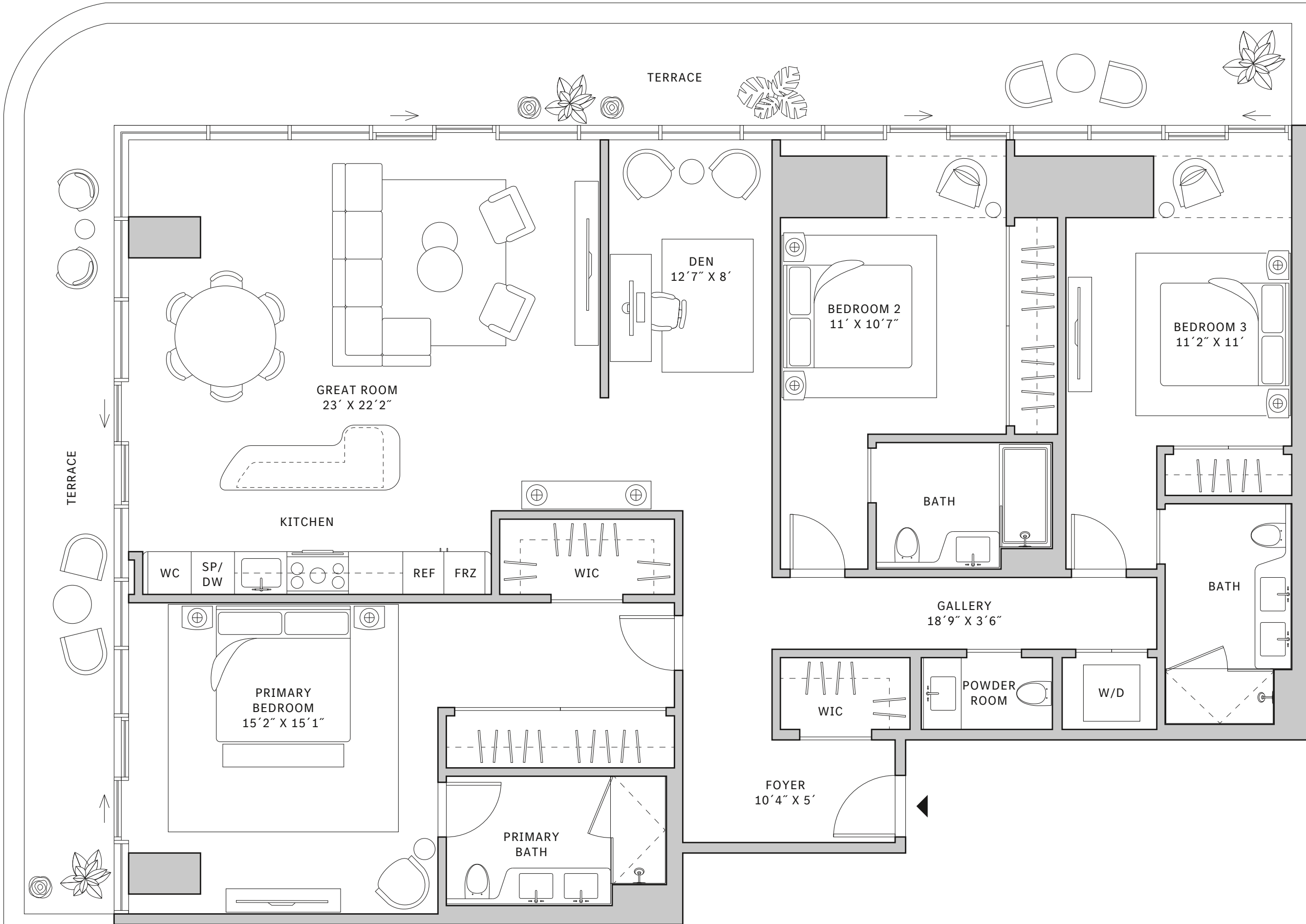

STATED DIMENSIONS ARE MEASURED TO THE EXTERIOR BOUNDARIES OF THE EXTERIOR WALLS AND THE CENTERLINE OF INTERIOR DEMISING WALLS AND IN FACT VARY FROM THE DIMENSIONS THAT WOULD BE DETERMINED BY USING THE DESCRIPTION AND DEFINITION OF THE "UNIT" SET FORTH IN THE DECLARATION (WHICH GENERALLY ONLY INCLUDES THE INTERIOR AIRSPACE BETWEEN THE PERIMETER WALLS AND EXCLUDES INTERIOR STRUCTURAL COMPONENTS). FOR YOUR REFERENCE, THE AREA OF THE UNIT, DETERMINED IN ACCORDANCE WITH THOSE DEFINED UNIT BOUNDARIES, IS SET FORTH IN EXHIBIT 3 TO THE DECLARATION OF THE CONDOMINIUM. NOTE THAT MEASUREMENTS OF ROOMS SET FORTH ON THIS FLOOR PLAN ARE GENERALLY TAKEN AT THE GREATEST POINTS OF EACH GIVEN ROOM (AS IF THE ROOM WERE A PERFECT RECTANGLE), WITHOUT REGARD FOR ANY CUTOUTS. ACCORDINGLY, THE AREA OF THE ACTUAL ROOM WILL TYPICALLY BE SMALLER THAN THE PRODUCT OBTAINED BY MULTIPLYING THE STATED LENGTH TIMES WIDTH. ALL DIMENSIONS ARE APPROXIMATE AND MAY VARY WITH ACTUAL CONSTRUCTION, AND ALL FLOOR PLANS AND DEVELOPMENT PLANS ARE SUBJECT TO CHANGE.



Site Photography

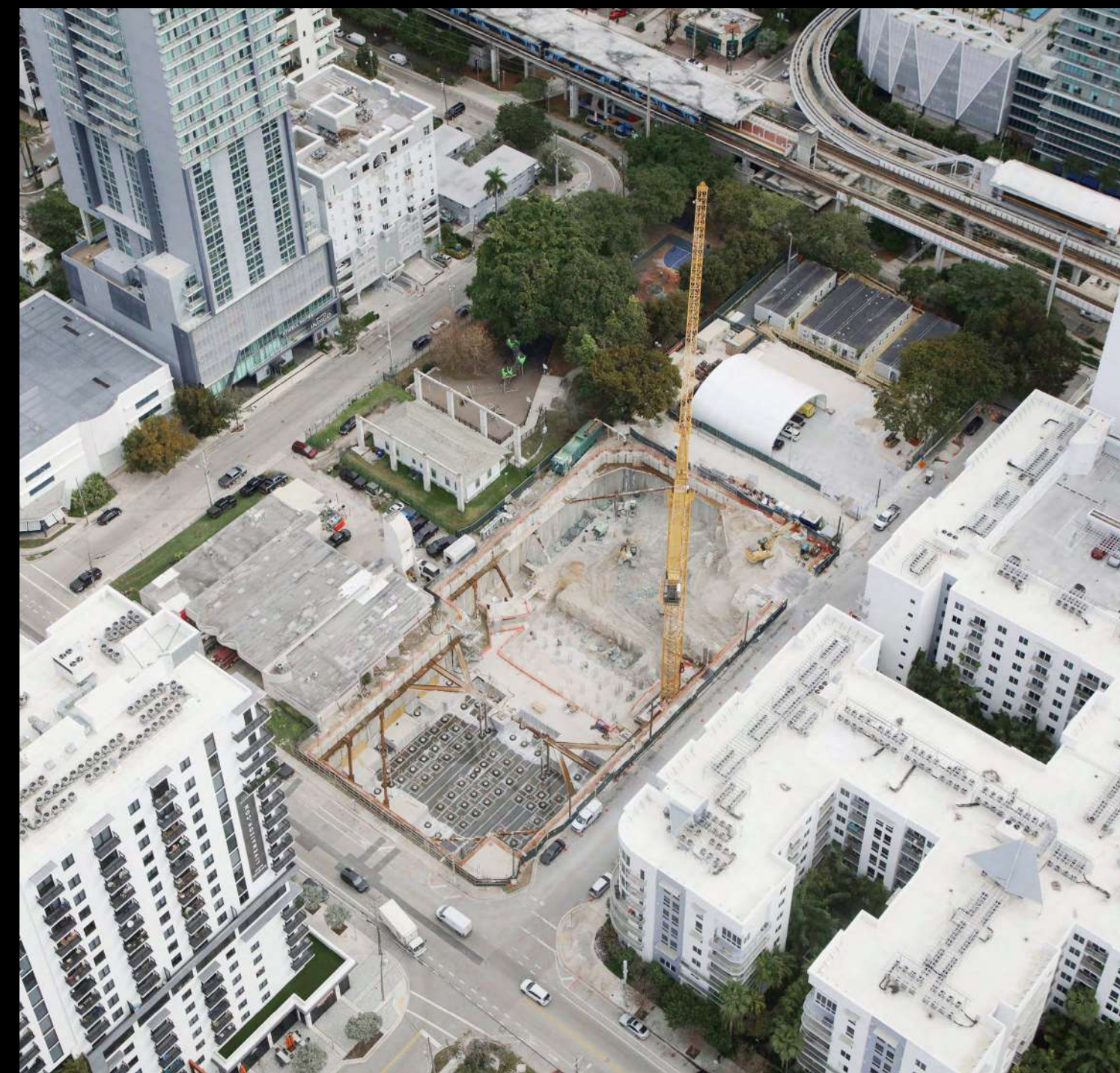
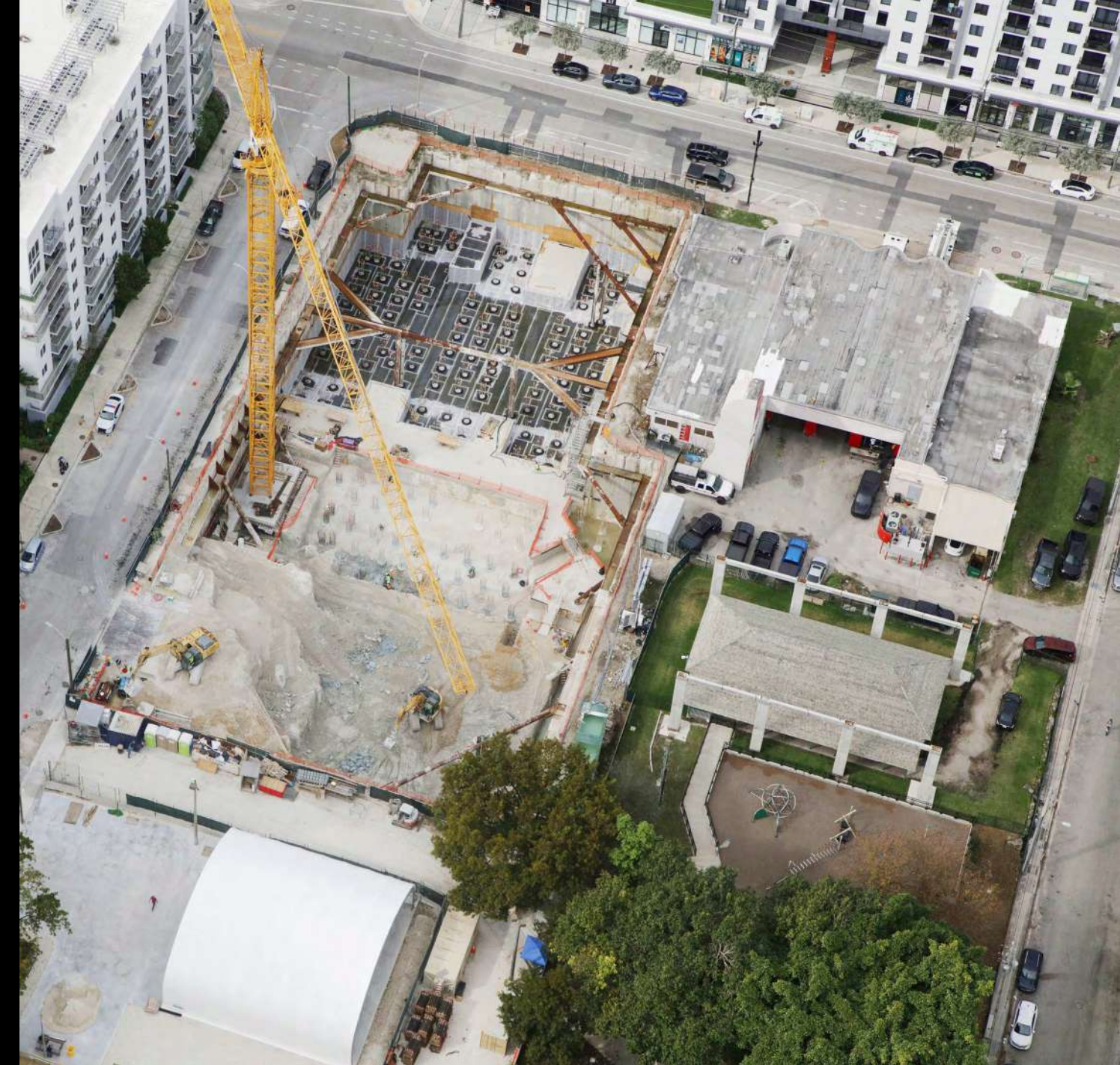

Sales Details

Deposit Structure

- ▲ 50% Buyer Deposits
 - ▲ 20% at Contract
 - ▲ 10% 180 Days from Signed Contract
 - ▲ 10% at Residence Level
 - ▲ 10% at Top-off
- ▲ 50% Balance Due at Closing

Commission Struction

- ▲ 6% Outside Broker Commission
 - ▲ 2% upon receipt by owner of a fully executed contract for the unit and receipt of 20% buyer deposit due thereunder
 - ▲ 1% 180 days from fully executed contract for the unit and receipt of 10% buyer deposit due thereunder
 - ▲ 1% upon completion of construction of the residential floor in the Condominium in which the unit is located and receipt of 10% buyer deposit due thereunder
 - ▲ 1% at top-off of the Condominium and receipt of 10% buyer deposit due thereunder
 - ▲ 1% at the Closing of the Unit

HOA Fee

- ▲ Tower 1 (South) with Reserves: \$1.53 ppsf

Rental Policy

- ▲ 2x Per Year, Every 6 Months

Construction Timeline

- ▲ Currently Under Construction
- ▲ Crane Installed on Site
- ▲ Anticipated Delivery Date: 2028

Hotel Operator

- ▲ Flag Not Publically Announced: Starwood Hotels & Resorts Worldwide
- ▲ Same Operator as 1 Hotels & Homes

Parking

- ▲ Valet and Self-parking Available
- ▲ Parking Spaces Not Included in Purchase
- ▲ Available First-come, First-serve for Monthly Fee (Fee at Market Rate)

Thank You

JDS
DEVELOPMENT
GROUP

1133 SW 2nd Avenue, Miami, FL 33130 | miami.mercedesbenzplaces.com

WE ARE PLEDGED TO THE LETTER AND SPIRIT OF THE U.S. POLICY FOR ACHIEVEMENT OF EQUAL HOUSING OPPORTUNITY THROUGHOUT THE NATION. WE ENCOURAGE AND SUPPORT AN AFFIRMATIVE ADVERTISING AND MARKETING PROGRAM IN WHICH THERE ARE NO BARRIERS TO OBTAINING HOUSING BECAUSE OF RACE, COLOR, RELIGION, SEX, HANDICAP, FAMILIAL STATUS OR NATIONAL ORIGIN.

This is not intended to be an offer to sell, or solicitation to buy, condominium units to residents of any jurisdiction where prohibited by law, and your eligibility for purchase will depend upon your state of residency. This offering is made only by the prospectus for the condominium and no statement should be relied upon if not made in the prospectus.

The sketches, renderings, graphic materials, finishes, plans, specifications, terms, conditions and statements contained in this brochure are proposed only, and the Developer reserves the right to modify, revise or withdraw any or all of same in its sole discretion and without prior notice. All improvements, designs and construction are subject to first obtaining the appropriate federal, state and local permits and approvals for same. These drawings and depictions are conceptual only and are for the convenience of reference and including artists renderings. They should not be relied upon as representations, express or implied, of the final detail of the residences or the Condominium. The developer expressly reserves the right to make modifications, revisions, and changes it deems desirable in its sole and absolute discretion. All depictions of appliances, counters, soffits, floor coverings and other matters of detail, including, without limitation, items of finish and decoration, are conceptual only and are not necessarily included in each Unit.

The condominium is not owned, developed or sold by Mercedes-Benz or any of its affiliates (the "brand"). Developer uses Mercedes-Benz marks pursuant to a license agreement with the brand, terminable according to its terms. The brand assumes no responsibility or liability in connection with the project, and makes no representation or warranty in respect thereof.

JDS Development and other parties named herein (collectively, the "Named Parties") are not the project Developer. This Condominium is being developed by 191 SW 12 Owner ("Developer"). Any and all statements, disclosures and/or representations shall be deemed made by Developer and not by Named Parties and any purchaser agrees to look solely to Developer (and not to Named Parties and/or any of its affiliates or principals) with respect to any and all matters relating to the marketing and/or development of the Condominium and with respect to the sales of units in the Condominium.